



Province of the
EASTERN CAPE
EDUCATION

**NATIONAL
SENIOR CERTIFICATE**

GRADE 10

NOVEMBER 2017

MATHEMATICAL LITERACY P1

MARKS: 75

TIME: 1½ hours



This question paper consists of 12 pages, including 2 annexures and 1 answer sheet.

INSTRUCTIONS AND INFORMATION

1. This question paper consists of FIVE questions.
2. Answer ALL the questions.
3. Use the ANNEXURES to answer the following questions:

ANNEXURE A for QUESTION 2
ANNEXURE B for QUESTION 4
ANSWER SHEET 1 for QUESTION 5.2
Write your NAME and GRADE in the spaces provided on the ANSWER SHEET and hand it in with your ANSWER BOOK.
4. Number the questions correctly according to the numbering system used in this question paper.
5. Diagrams are NOT necessarily drawn to scale.
6. Round off ALL the final answers appropriately according to the context used, unless stated otherwise.
7. Indicate units of measurement, where applicable.
8. Start EACH question on a NEW page.
9. Show ALL calculations clearly.
10. Write neatly and legibly.

QUESTION 1

1.1 The two graphs below show the relationship between two quantities. GRAPH A shows the number of grass cutters and the time they take to cut the grass whereas GRAPH B shows the amount of food required to feed a number of fish. Study the graphs to answer the questions below.

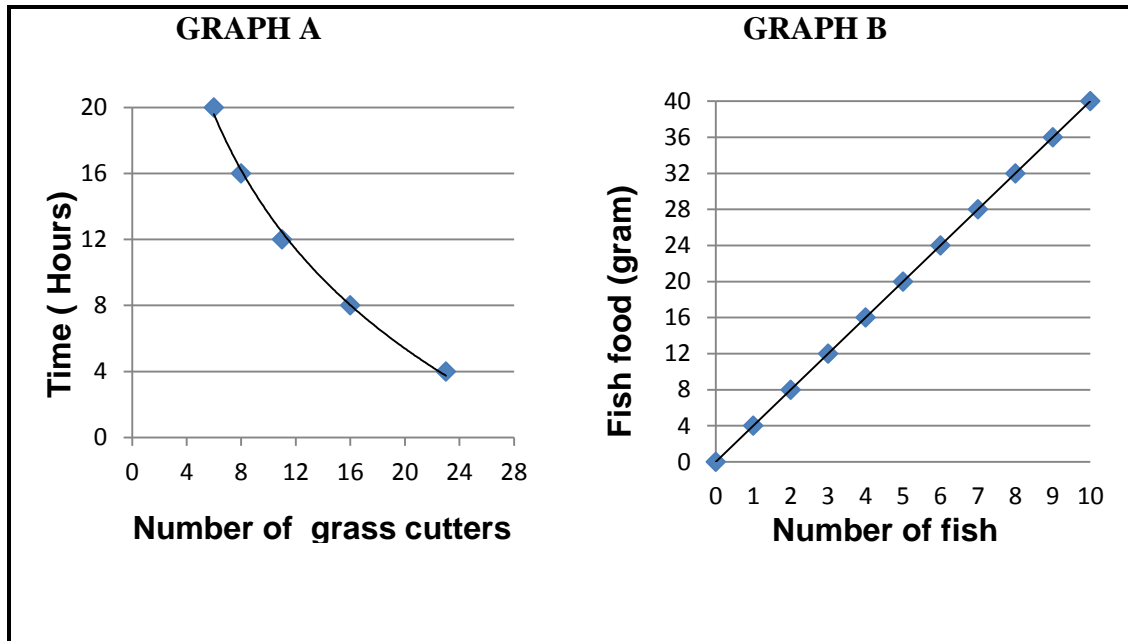

- 1.1.1 GRAPH A shows the proportion of grass cutters in relation to the time they take to cut the grass. What type of proportion is shown by GRAPH A? (2)
- 1.1.2 According to GRAPH B the ratio of fish food to number of fish is 40 : 10. Simplify the given ratio. (2)
- 1.1.3 What type of proportion is shown by GRAPH B? (2)
- 1.2 Austin is a Grade 9 learner at Masizakhe Secondary School and decides to sell black pens to make some extra pocket money.
 - 1.2.1 If the total cost for a pack of 12 pens is R42,00, how much does each pen cost? (2)
 - 1.2.2 He decides to sell each pen for R5,00. Calculate the percentage profit he will make.

You may use the following formula:

$$\% \text{ profit} = \frac{\text{Selling price} - \text{Cost price}}{\text{Cost price}} \times 100\%$$

(3)

- 1.3 Mrs Bales has decided to buy a new stove to make her cooking and baking easier. She shopped around and found a four-plate stove shown below.

| | |
|---|--|
| <p>Cash price: R4 999</p> <p>Account: 10% deposit and R369, 89 per month Terms: 24 months</p> |  |
|---|--|

- 1.3.1 Write down the cash price in words. (2)
- 1.3.2 Calculate the deposit needed if she decides to buy the stove on account. (2)
- 1.3.3 Calculate the total amount she will pay for the stove if bought on account. (3)
- [18]**

QUESTION 2

Mr. V. Manga is a homeowner and receives monthly account statements from the municipality for rates and services. ANNEXURE A refers to the municipality account statement he received. Study the statement and answer the questions that follow.

- 2.1 State the name of the municipality that has issued the account statement. (2)
- 2.2 Write down the date on which this statement was issued. (2)
- 2.3 Explain what the amount -R800,00 means in ANNEXURE A. (2)
- 2.4 Show how the VAT of R25,79 charged on 'refuse domestic' was calculated. (2)
- 2.5 Mr V. Manga used an average of 13 *kl* of water for the month of June. Use the water tariff charges given in ANNEXURE A to determine the total amount payable for water charges. (3)
- 2.6 Calculate the value of A. (3)

[14]

QUESTION 3

- 3.1 Nosizwe wants to start up a business selling cupcakes which she will bake using her grandmother's recipe. Below is a list of ingredients needed to make 8 cupcakes. Study the information below to answer the questions.

| |
|---|
| <p style="text-align: center;">INGREDIENTS (8 CUPCAKES)</p> <p>100 ml margarine 125 ml castor sugar 1 egg 1ml vanilla essence 250 ml cake flour 7 ml baking powder 40 ml water 40 ml milk 8 paper cups for cupcakes</p> <p style="text-align: center;">INGREDIENTS: BUTTER ICING</p> <p>40 ml soft margarine 190 ml icing sugar, sifted 7 ml boiling water</p> <p>NOTE: recommended measuring instruments that should be easily available in most households</p> <p style="text-align: center;">1 cup = 250 ml 1 spoon = 10 ml 1 teaspoon = 5 ml</p> |
|---|

- 3.1.1 Identify the recommended measuring instrument that will be suitable to measure water. (2)
- 3.1.2 How many milliliters of baking powder may be required to make 24 cupcakes? (3)
- 3.1.3 Nosizwe pre-heats the oven at 356 °F. Convert the pre-heat temperature to degrees Celsius (°C).

The following formula may be used:

$$^{\circ}\text{C} = \frac{(^{\circ}\text{F} - 32^{\circ})}{1,8} \quad (3)$$

- 3.2 She will need a tray to display or deliver her cupcakes to customers. Below is a tray with the following dimensions that she will be using : length = 40 cm, width = 20 cm and height = 6 cm.

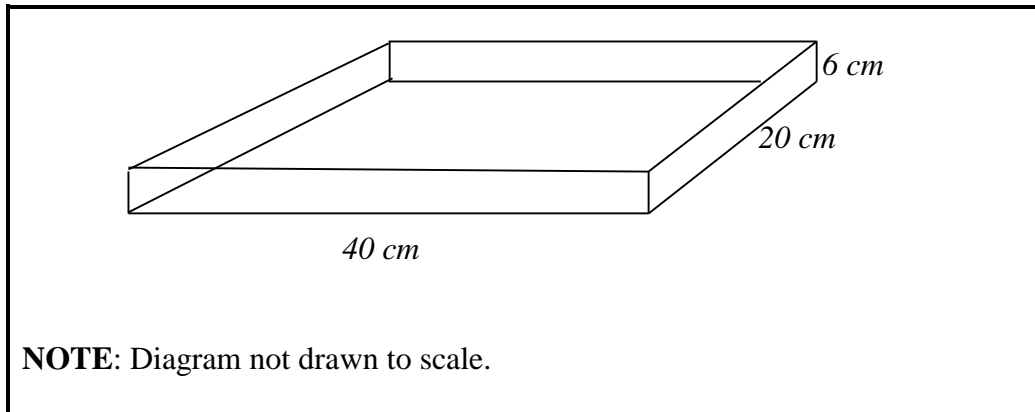

You may use the following formulae:

- **Perimeter** = $2(l + w)$
- **Volume** = $l \times w \times h$

3.2.1 Explain what the term *perimeter* means.

(2)

3.2.2 Calculate the volume of the tray.

(2)

[12]

QUESTION 4

The Jason family has bought a new home. The floor plan of the house is shown in ANNEXURE B. Study the floor plan in ANNEXURE B and answer the questions that follow.

- 4.1 What is the compass direction of bedroom 3 from the lounge? (2)
- 4.2 How many windows are shown on the floor plan? (2)
- 4.3 How many interior doors are shown on the floor plan? (2)
- 4.4 Using your ruler, determine the dimensions of bedroom 1 on the floor plan. (2)
- 4.5 Using the given scale, calculate the actual area of bedroom 1 in square meters (m²).

You may use the following formula:

$$\text{Area of rectangle} = \text{length} \times \text{width} \quad (3)$$

[11]

QUESTION 5

- 5.1 The data shown below represents the Grade 10 Mathematical Literacy test percentages for learners from Masiqinise Secondary School.

| | | | | | | | | | |
|-----------|-----------|-----------|-----------|-----------|-----------|-----------|-----------|-----------|-----------|
| 45 | 47 | 34 | 48 | 47 | 42 | 39 | 22 | 54 | 17 |
| | | | | | | | | | |
| 32 | 67 | 25 | 39 | 34 | 64 | 47 | 50 | 62 | |
| | | | | | | | | | |

- 5.1.1 Arrange the values in ascending order. (2)
- 5.1.2 Refer to the data shown above and determine the median. (2)
- 5.1.3 Determine the mode of the data represented above. (2)
- 5.1.4 Show by calculation that the range is 50%. (2)
- 5.1.5 Calculate the average percentage of this Grade 10 class. (3)
- 5.1.6 Based on the data represented above, determine the probability that a learner from this class has a percentage less than 30% in the test. Write your answer to the nearest percentage. (4)







5.2 Complete the frequency table for the Mathematical Literacy test percentages shown above in QUESTION 5.1. Use the table drawn in ANSWER SHEET 1 to answer this question.

| Interval | Tally | Frequency |
|-----------------|--------------|------------------|
| 0–29 | | |
| 30–39 | | |
| 40–49 | | |
| 50–59 | | |
| 60–69 | | |
| Total | | |

(5)
[20]

TOTAL: 75

ANNEXURE A FOR QUESTION 2

| Date | | Service | Details | | | Charge (excl VAT) | VAT | Charge (incl VAT) |
|---|---------|--|--|-----------|--|-------------------|---------------------------|-------------------|
| 22/04/17 | | | BALANCE BROUGHT FORWARD | | | | | R1 433,18 |
| 24/04/17 | | | CC – THANK YOU | | | -R800,00 | R0,00 | -R800,00 |
| 20/05/17 | | | SUB TOTAL | | | R633,18 | R0,00 | R633,18 |
| 20/05/17 | |  | FIRE LEVY DOMESTIC | | | R39,47 | R5,53 | R45,00 |
| 20/05/17 | |  | PROPERTY RATES RESIDENTIAL | | | R216,40 | R0,00 | R216,40 |
| 20/05/17 | |  | MARKET VALUE REBATE | | | -R12,15 | R0,00 | -R12,15 |
| 20/04/17 | |  | REFUSE DOMESTIC | | | R184,21 | R25,79 | R210,00 |
| | |  | METER-NO 54121 TARIFF: WATER DOMESTIC INTERIM 10 KI | | | R120,11 | R16,82 | R136,93 |
| | |  | SEWAGE DOMESTIC BASIC 366 M ² TOTAL CURRENT LEVY 716.41 | | | R104,76 | R14,67 | R119,43 |
| Current | 30 Days | 60 Days | 90 Days | 90 Days + | Total Charged (excl VAT) | Total VAT | Total Charged (Incl. VAT) | |
| R715,61 | R633,18 | R0,00 | R0,00 | R0,00 | R1 285,98 | R62,81 | A | |
| ELECTRICITY | | WATER TARIFF | | | The supply of service may be discontinued if any amount is unpaid after the due date and the deposit may be reviewed simultaneously. | | | |
| | | 6 kl @ 11.917550 4 kl @ 12.151250 10 kl @ 16.876510 10 kl @ 21.876960 30+ kl @ 27.454360 | | | | | | |
| DIRECT DEPOSIT / ATM / INTERNET BANKING | | | | | | | | |
| Bank | | | | | ABSA | | | |
| Branch No. | | | | | 632005 | | | |
| Bank Account No. | | | | | 4 080 090 388 | | | |
| Your Municipal Account No. | | | | | 10144653 | | | |

[Adapted from: www.buffalocity.docview.co.za]

ANSWER SHEET 1

QUESTION 5.2

NAME:

GRADE:

| Interval | Tally | Frequency |
|-----------------|--------------|------------------|
| 0–29 | | |
| 30–39 | | |
| 40–49 | | |
| 50–59 | | |
| 60–69 | | |
| Total | | |

ANNEXURE B FOR QUESTION 4

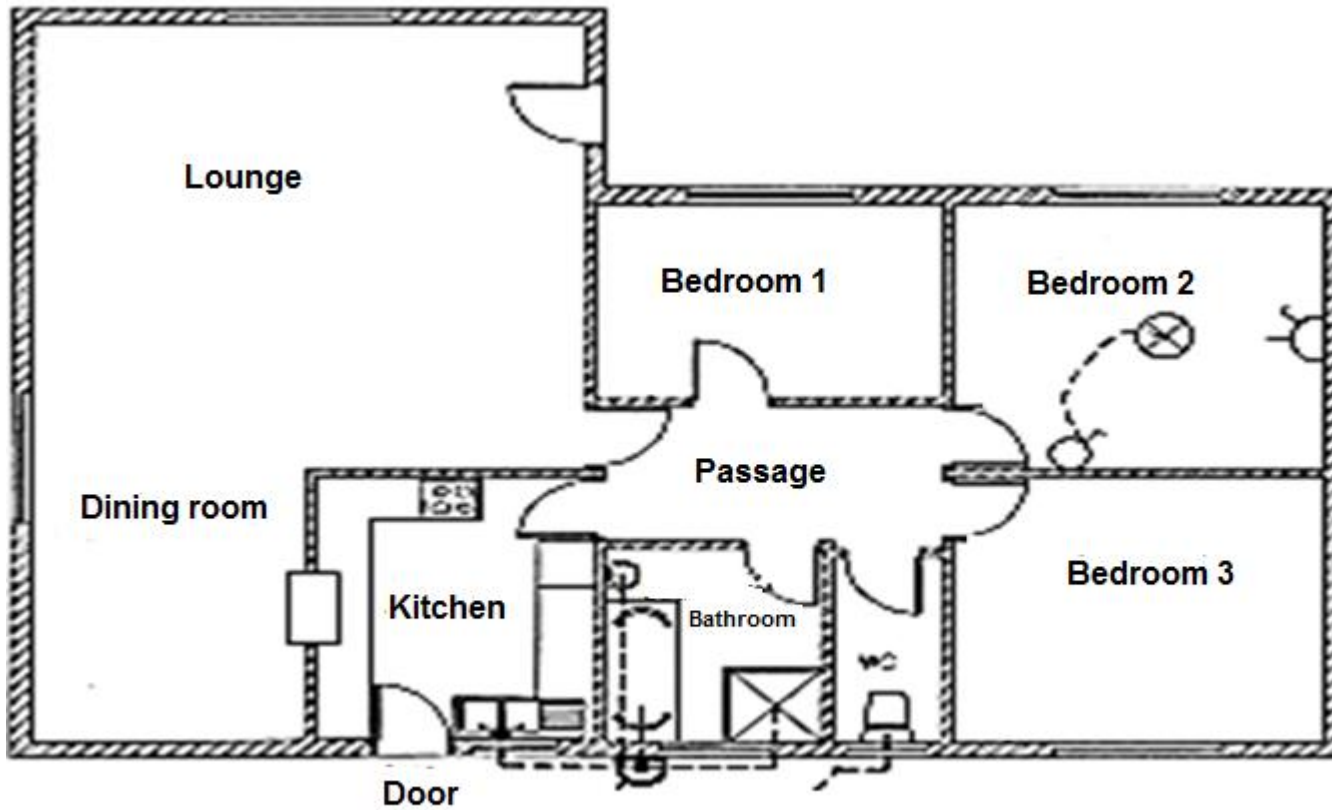

Scale 1 : 120

